



Directional Sector Antenna



Tip: Pictures are for reference only.
Please refer to physical objects.

- Model: FTD-5158SH17V90C
- Name: Directional Sector Antenna
- Freq.Range: 5150 to 5850 MHz
- Communications system:
5.1 to 5.8GHz WALN/WIFI/ISM/UNII,
5.1 to 5.8GHz Spread Spectrum Communication
- Application scenario:
Point to multipoint, Base station antenna,
Outdoor signal directional coverage,
Wireless data and image transmission,
Public wireless hotspot coverage,
IEEE802.11a/n

Electrical Specifications

Freq.Range-MHz	5150 to 5850
Bandwidth-MHz	700
Polarization	Vertical
Gain-dBi	17
Beam Electrical Downtilt-°	0
Half-power beam width-°	H: 90 E: 7
F/B-dB	≥ 23
Impedance-Ω	50
VSWR	≤ 2.0
Max.Power-W	50
Lightning Protection	DC Grounded

Mechanical Specifications

Connector	N female
Connector Position	Bottom
Dimension-MM	About 454×137×30
Weight-KG	About 0.8
Radome material	ABS
Radome color	White
Mechanical tilt-°	0 to 30
Operational Temperature-°C	-40 to 60
Storage Temperature-°C	-55 to 85
Relative Humidity-%	5 to 95
Rated Wind Velocity-M/S	60
Mounting way	Mast
Mast Diameter-MM	Φ35 to 60



Installation Demonstrations

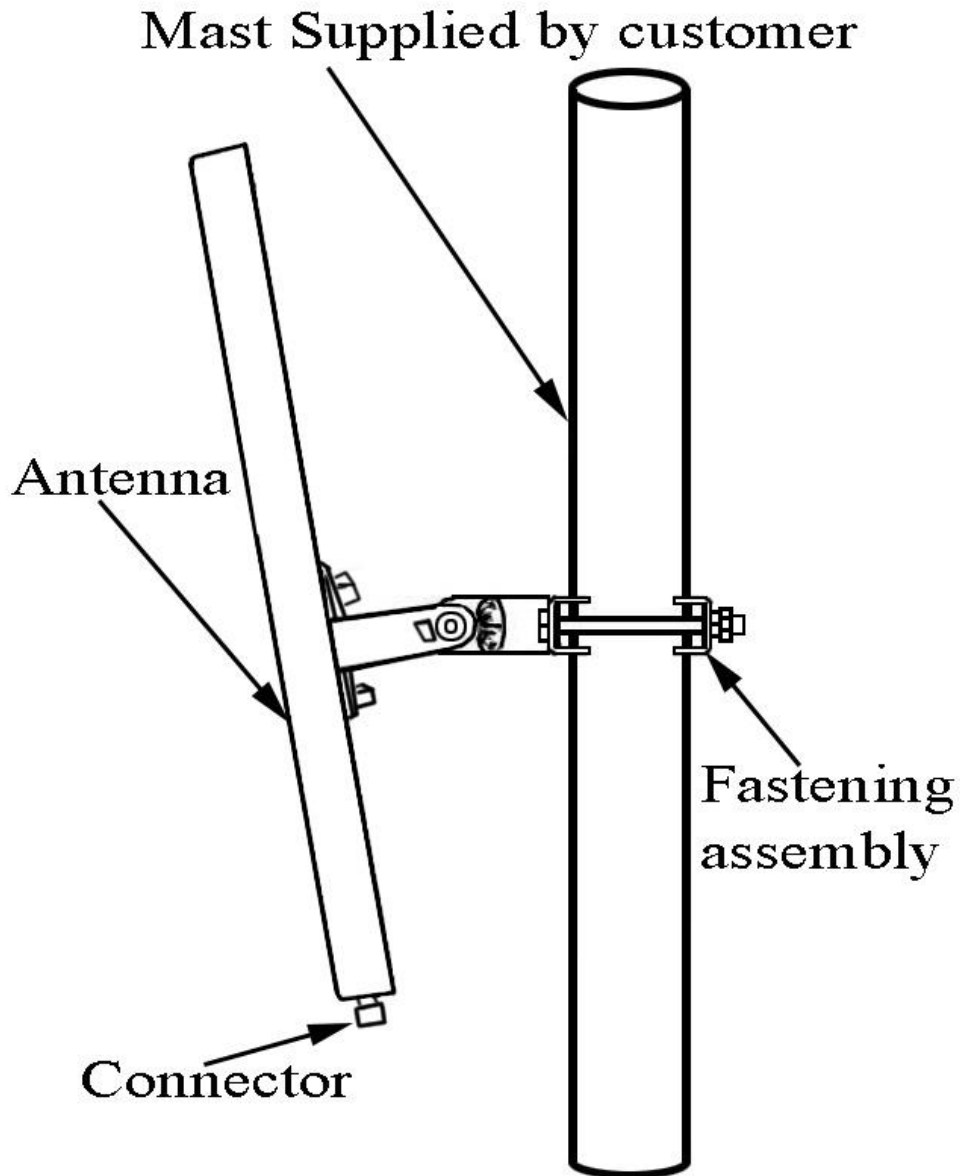

Typical pattern & Communication channel

